

The Historic Huntsville Quarterly

Volume 7 | Number 1

Article 2

9-1-1980

The Historic Huntsville Quarterly of Local Architecture and Preservation, Vol.7, No.1, Fall 1980

Historic Huntsville Foundation

Follow this and additional works at: <https://louis.uah.edu/historic-huntsville-quarterly>



Part of the [Historic Preservation and Conservation Commons](#), and the [History Commons](#)

Recommended Citation

Historic Huntsville Foundation (1980) "The Historic Huntsville Quarterly of Local Architecture and Preservation, Vol.7, No.1, Fall 1980," *The Historic Huntsville Quarterly*. Vol. 7: No. 1, Article 2. Available at: <https://louis.uah.edu/historic-huntsville-quarterly/vol7/iss1/2>

This Full Issue is brought to you for free and open access by LOUIS. It has been accepted for inclusion in The Historic Huntsville Quarterly by an authorized editor of LOUIS.

One Dollar

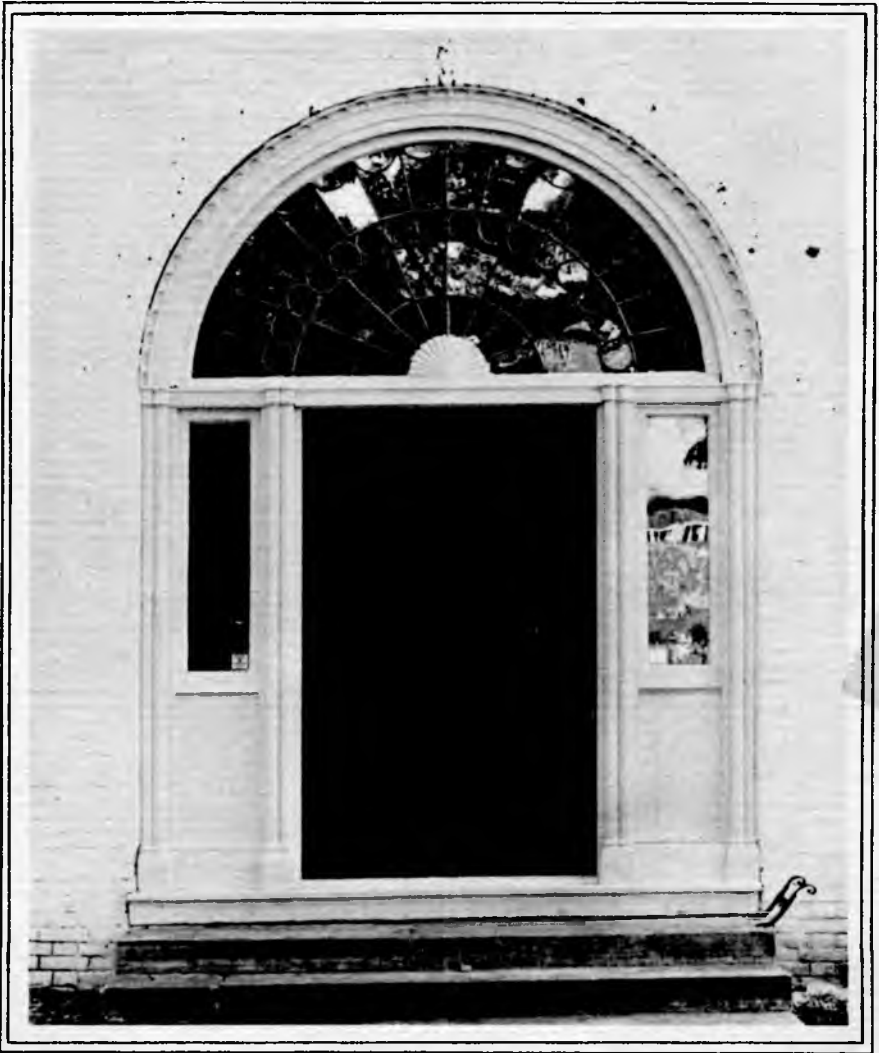

Fall

1980

THE HISTORIC HUNTSVILLE
QUARTERLY

Of Local Architecture & Preservation

THE HISTORIC HUNTSVILLE QUARTERLY

of Local Architecture and Preservation

Vol. VII, No. 1

Fall 1980

Contents

- 3 FEDERAL PERIOD RESIDENTIAL ARCHITECTURE
In Huntsville and Madison County, 1805-1835
by Harvie Jones

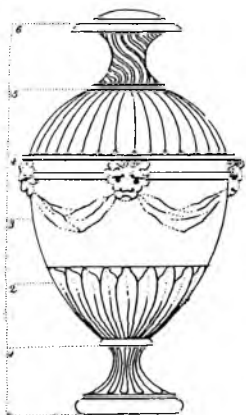

THE HISTORIC HUNTSVILLE QUARTERLY
is published four times a year by
the Historic Huntsville Foundation,
Inc., P. O. Box 786, Huntsville,
Alabama 35804. Linda Bayer, Editor;
Lynn Jones, Associate Editor. Sub-
scriptions are mailed free to all
members of the Foundation.

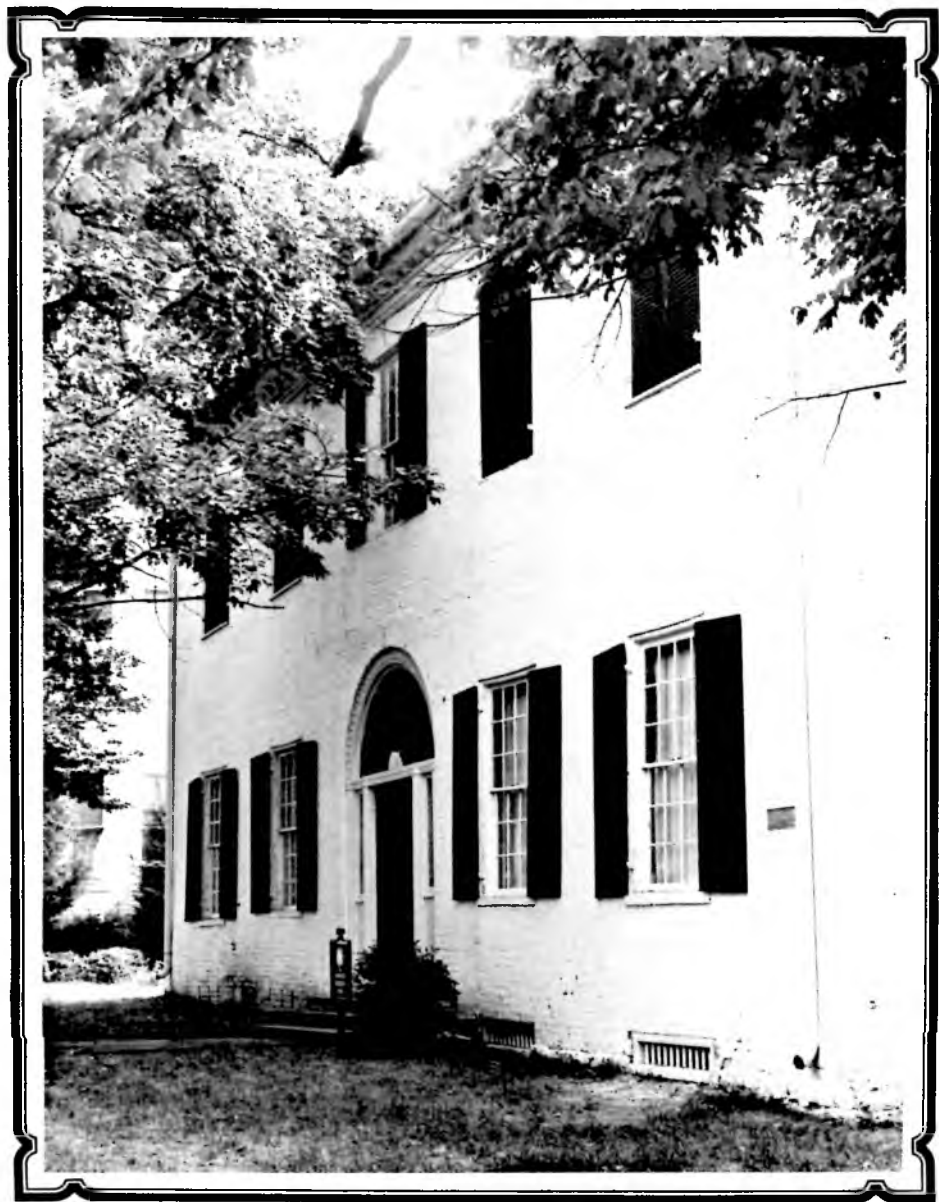

WEEDEN House, 300 Gates Street; entry featured on COVER.

by Harvie Jones

FEDERAL PERIOD

RESIDENTIAL ARCHITECTURE

HISTORICAL BACKGROUND

The style termed "Federal" has also been called "Adam" and, in England, "Anglo-Greco-Roman." "Neoclassic" is the term which might most accurately describe the essence of the American synthesis of the style, with emphasis on the influence of ancient Roman decorative devices as uncovered and recorded at Spalato, Pompeii and Herculaneum in the mid-18th century. Architectural handbooks of the early 19th century routinely began with archaeologically correct details of the classical Greek and Roman orders, and then progressed to improvise on and adapt ancient urns, swags, molds, and floral designs to the needs and tastes of the early 1800s. The primary interpreter of that

taste in the latter part of the 18th century was the English architect Robert Adam.

The United States has few full-blown examples of the flamboyant Adam style such as Boscobel, an 1805 confection of swags and balustrades on the Hudson River. In Madison County, the Adamesque exuberance is confined to the mantels and stairs primarily, and sometimes is found on the entry and, in the case of the 1819 Weeden House, on the baseboards and trim of interiors. The basic shape of the Federal period houses here is simple and restrained, with the Adamesque ornament applied on selected parts to the degree that economics and the owner's taste decreed.

In Huntsville and Madison County
1805 - 1835

*BOSCOBEL, Garrison, New York,
1805-1807.*



The Federal period of American architecture is generally considered to extend from the Revolutionary War to the Greek Revival, which began in the 1820s on the stylistically advanced eastern seaboard and about a decade later in remote Huntsville. Therefore Huntsville's Federal period began with the town's settlement in 1805 and extended generally to 1835.

As in all forms of art and technology, architectural periods have considerable overlap, and there are several houses here of the 1840s and 50s that are still Federal in character, except with up-to-date Greek Revival trim, mantels and porches, such as the ca. 1855 Dill-Rice House.

This stylistic overlap also extends backward toward the 18th century Georgian period. An examination of the vernacular Georgian house (not the high-style Palladian examples)

HUNTSVILLE HOUSES CITED

- | | |
|---|--|
| *BONE-WILBOURN House
1162 Hurricane Creek Road
Hurricane Valley | PHELPS-JONES House
6112 Pulaski Pike |
| BRICKELL House
614 Franklin Street | *POPE House (Echols Hill)
403 Echols Avenue |
| CABANISS-ROBERTS House
603 Randolph Street | PUBLIC INN
205 Williams Avenue |
| CLEMENS House
219 West Clinton Avenue | RHETT House
621 Franklin Street |
| COX-HILSON House
311 Lincoln Street | *SHEPHERD House
505 Holmes Street |
| DILL-RICE House
118 Calhoun Street | *SPRAGUE-CHADWICK House
307 Randolph Street |
| *FEENEY-BARBER House
414 Randolph Street | STEELE-COONS House
519 Randolph Street |
| *GROVE-BASSETT House
600 Franklin Street | *WEEDEN House
300 Gates Avenue |
| LEWIS-SANFORD House
601 Madison Street | *WINSTON-ORGAIN House
401 Lincoln Street |
| *Illustrated | YEATMAN-BECK House
528 Adams Avenue |



BASSETT HALL, Williamsburg, Virginia, ca. 1760.

of mid-18th century Virginia reveals that the major difference between vernacular Georgian and vernacular Federal is in decorative features, with the basic building forms being very similar (Bassett Hall). The major reasons for the retention of these basic forms from the mid-18th to the mid-19th century are that they were practical, functional, familiar and attractive--good reasons, indeed.

Probably the major characteristics of Federal period architecture are the lightness and delicacy of the Adamesque decorative detail. By comparison, Georgian interior decorative trim, while equally elaborate, is much heavier in scale, possibly because it was patterned on exterior Roman ornament. The Greek Revival detail is simpler but is (appropriately) heaviest of all in scale.

A major influence in bring-

ing about this lightness and delicacy of decorative detail in the Federal period was the discovery of the architecture of the ancient Roman ruins at Spalato and the cities of Herculaneum and Pompeii, which had been buried under volcanic ash in 79 A.D. and were excavated in the mid-18th century. One of those surveying the ruins at Spalato was the young English architect and designer Robert Adam, who made extensive drawings of the ancient architectural details and published in 1764 a folio entitled *Ruins of the Palace of the Emperor Diocletian at Spalato*. Robert Adam and his two brothers became a major influence in the design world. Their synthesis of the delicate ancient Roman decorative features such as swags, urns, slim colonettes and delicate moldings had a strong effect on architecture in England and the United States through the numerous architectural handbooks published in the period, such

as *The American Builder's Companion*, first published in 1806 in Boston by the architect Asher Benjamin.

In the early 19th century a knowledge of architecture was considered to be an integral part of a good education. Records show that individuals' libraries frequently contained several books on architecture and building, such as Asher Benjamin's. Since small rural towns like Huntsville had no architects (George Steele began building here in the 1820s), it is apparent that handbooks, together with the memories, imagination and skills of the owner and builder, were the primary influences on such elaborate and refined designs as those found in the Weeden House.¹ This system obviously worked well, for some of our most handsome architecture was produced in a time when architectural handbooks must have been the major design resource.

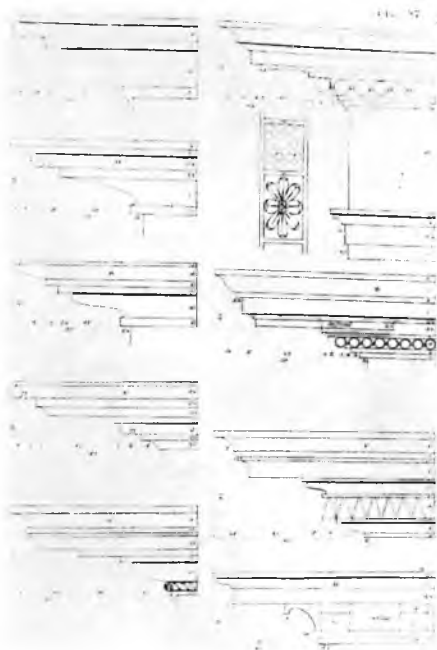
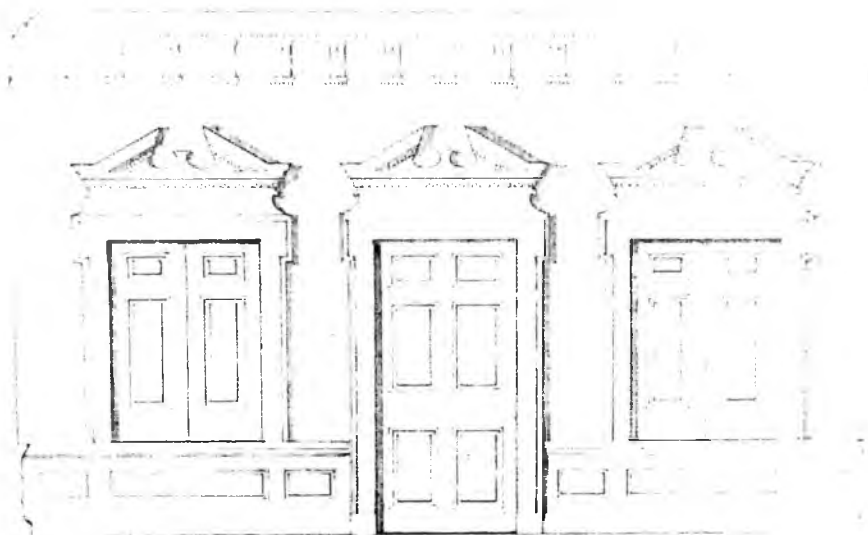

Plate 27 from Asher Benjamin's *AMERICAN BUILDER'S COMPANION* showing the Adamesque influence on cornices and molds.

An example of Georgian interior decoration from a Maryland house.



PLAN ARRANGEMENTS

Surviving Federal period houses in Huntsville indicate that the majority began as essentially two-room, two-story houses (one room per floor) with perhaps two service rooms (kitchen and servants') in a detached structure in the rear, and frequently a small room about eight feet square at the front of the upper stair hall. A few such examples are the Sprague-Chadwick, Cabaniss-Roberts, Feeney-Barber, Rhett, and Brickell houses. Several of these, such as the last two named, appear at a glance to have been built of-a-piece as a center hall house, but a closer look reveals clear and numerous evidences of an addition having been made to the side of the small original house to achieve a center hall design.

We might wonder how a family could manage in a house that consisted essentially of two main rooms, a kitchen, and a servant's room. The answer, histories tell us, is that only in relatively recent times have room functions become highly specialized and a separate room provided for each child. These early 19th century rooms were large, generally about 18 to 20 feet on a side, and were multi-purpose. The downstairs parlor might contain both a dining table (which held a lamp or candle and also served as an evening reading table) and the parents' bed. It was not thought to be unseemly to receive visitors in a room containing a canopied and curtained bed. The upstairs room might contain two or more beds, and a single bed might accommodate several children.² Since most of these two-room houses

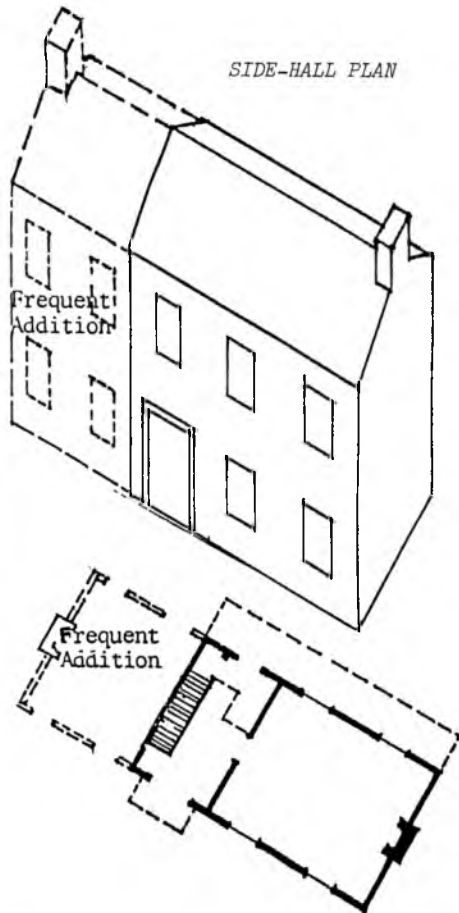

FEENEY-BARBER House, 414 Randolph

were added to fairly early in their history, their original builders may have considered them to be "starter" modules with the expectation that they would be enlarged as finances and number and sex of children indicated. Based on the architectural evidence, many of the Federal period two-room houses were enlarged to four or six rooms within a decade or so of their original construction. A few were built large initially, such as the six-room, ell-plan Weeden house of 1819.

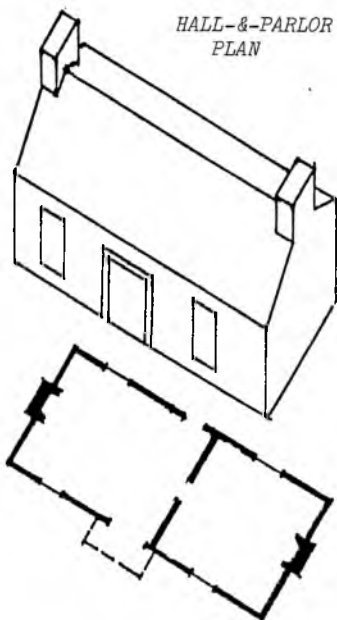

HALL-&-PARLOR
PLAN

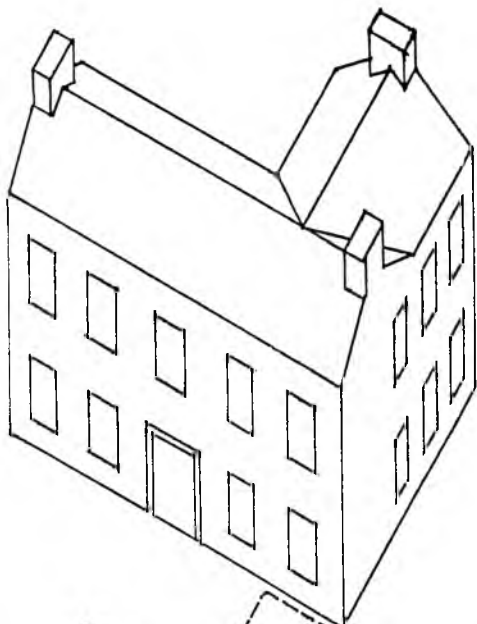

The smallest known Federal period house here is the one-story, ca. 1828, Shepherd House. The original two front rooms are several feet less than the usual 18 to 20 foot dimensions, and there is no entry hall. The front door is approximately centered and opens directly into the larger of the two rooms, creating what is known as a "hall and parlor" plan. The larger room is the "hall" (in the medieval sense), and the smaller room is the "parlor" (which surely served as a bedroom).

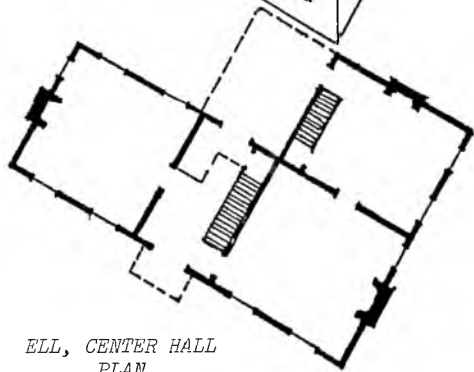

ELL, CENTER HALL
PLAN

Another interesting plan arrangement was the house that once stood on Banister Alley (recently reconstructed in somewhat the Federal configuration), which initially had one room on each floor, but no enclosed stair. The second floor room was reached by going out onto the back porch and mounting a stair that ascended under the steep porch roof.



SHEPHERD House, 505 Holmes

Numerous Federal period houses had stairs that opened directly into an upper bedroom rather than being separated in a stair hall. Two examples are the house on Homer Nance Road near Three Forks of Flint and the Weeden House. Other houses, such as the Cabaniss-Roberts House with its west wing addition, had rooms "in series" so that the farthest bedroom could only be reached by passing through another bedroom. In more distant times, this was a usual arrangement even in palaces. Corridors and privacy are relatively modern ideas.

The kitchen was usually placed in a building that was totally separated from the house, frequently without even a porch to provide shelter between the two. An extant example is the 1814 kitchen building at the LeRoy Pope House

(now called Echols Hill) on Echols Avenue. Sometimes however, a kitchen was placed inside the ground floor of "raised" houses (where the ground floor is sunk several feet into the soil). One example of this that comes to mind is the architect George Steele's original house at 519 Randolph, where the cooking crane was recently found still mounted inside the bricked-up fireplace in the rear ground-floor kitchen.

In addition to the kitchen, there would usually be servants' rooms, a smokehouse, shelter for horses and conveyances, a well-house, the "necessary," and perhaps other outbuildings. Madison County still has a surprising number of these outbuildings, except for the "necessaries" (privies); the last one known to the writer, which

was very old if not Federal, was a handsome example with beaded clapboard, wood shingled roof, and vestibule at the 1820s Bone-Wilbourn House in Hurricane Valley.

PORCHES

Architectural evidence confirms that many town houses of the early 19th century (here and elsewhere) had no roofed entry porch of any sort. The entry was exposed and the steps descended, sometimes without a landing at the top, directly to the ground. Three such examples are the Feeney-Barber, Sprague-Chadwick, and Weeden houses. Where entry porches were present, they were small and classical, such as on the Lewis-Sanford and Cabaniss-Roberts houses. Many Federal houses now have latter 19th century or early 20th century porches, and frequently these are complementary additions, even though the porch might be a flamboyant Vic-

torian object set against a staid Federal house. Two such happy instances are the Shepherd House and the Yeatman-Beck House.

Large rear porches, good for shelling peas and such, were apparently usual. Frequently they extended across the entire rear of the house.

ENTRIES AND WINDOWS

The incorporation of windows in some form at the entry was normal both for light and ventilation of the entry area. At a minimum there would be a rectangular operable transom (Sprague-Chadwick). In many cases there would also be sidelights, sometimes operable (Winston-Orgain). On more elaborate houses there would be a toplight of elliptical (Winston-Orgain) or semicircular shape (Grove-Bassett), sometimes of leaded glass (Weeden). Doors were frequently paired, with

SPRAGUE-CHADWICK Entry, 307 Randolph



FEENEY-BARBER Entry, 414 Randolph



blinds that could be closed over the open doors to provide the same functions as screened doors (which were not available until the late 19th century).

Windows similarly were provided with blinds, usually with moveable slats, to provide ventilation with privacy, sun protection, and some insect protection. At the time, these were called "Venetian blinds," after their Italian origin, and are properly termed "blinds" rather than "shutters," which are solid and without slats.

While sashes were usually placed individually in a wall, sometimes three were grouped to form a "modified Palladian" window--a normal sized sash flanked by two narrow sashes, but without the semicircular Palladian top to the central sash (Winston-Orgain).

Glass panes were small--usually ten by twelve inches or

eight by ten inches--since they had to be hauled from far away. The glass is "cylinder glass," meaning that first it is hand-blown into elongated bubbles, then has the ends cut off to form a cylinder, is reheated, sliced along the cylinder's side, and flattened. Therefore ripples, waves and bubbles are characteristic. The glass is very thin and fragile--about one-sixteenth of an inch thick. While we now regard this irregular glass as beautiful, much of it was discarded in the latter 19th century when clearer, bigger panes became available.

Various devices were used to lock sashes shut and to hold them open. The simplest is a wooden turn-latch which, due to its clever shape and placement, performs both functions; an example can be seen on the second floor of Constitution Hall. While sashes with ropes and weights were available, they were probably not common;

POPE House Entry, 403 Echols



GROVE-BASSETT Entry, 600 Franklin





WINSTON-ORGAIN House, 401 Lincoln

it is possible that those in the Weeden House were originally of this type.

Federal period rooms usually had four large windows, two each on opposite sides of the room, and these rooms are consequently much brighter than rooms in most modern houses.

HEATING AND VENTILATION

While major rooms each had a fireplace, the small room in the upper stair hall and the stair hall itself had no heat. The houses had no subfloors, so drafts through the floor and around the doors and windows were a major problem in extremely cold weather. Interior doors had raised wood sills to help block the drafts, and floors were frequently covered with carpet sewn in yard-wide strips that extended wall-to-wall to stanch the cold air, as well as for fashion. A fabric-covered cylindrical "pillow"

pushed against the door bottom also helped. The direct radiation of heat from the fireplace, plus lots of clothing, was the only way to get warm. Contemporary accounts confirm that these houses were better suited to summer than to winter, as the following recollection by Lillian Bone Paul reveals:

Wood fires, in a house with central heating, are very lovely. But if they are to be the source of warmth, they are less than satisfactory. As I have said, the rooms were huge--18 x 18 if I am not mistaken and with high ceilings. The fireplaces were in proportion, but most of the heat went up the chimney, and a hand laid on the chairboard could feel the cold wind rising from behind the panelling. Anyone facing the fire was warm in front, and in fact, might be baking, while his back was quite cold. One year Grandpa figured out a scheme to trap the heat and had

Grandma make heavy curtains of carpeting, which he had strung on a wire across the middle of the room, cutting down its area, but as well as I remember, not helping the temperature. ³

In summer, the two-story brick houses (with shade trees) were particularly well adapted to this climate. The thick brick walls have a "flywheel" effect, cooling off at night and radiating the coolness during the day. The two-story stairwell acts as a chimney, drawing warm air up and out and consequently pulling cooler air into the well ventilated rooms.

Chimneys were typically placed at the ends of the house, although some houses have the chimneys at the ridge line or at the rear wall (Clemens and Sprague-Chadwick houses). The gable projections on the Sprague-Chadwick House which appear to be chimneys are false, put there apparently to make the house "look right." At least two other Federal period houses here have false chimneys

Cornice detail and leader head of POPE House, 403 Echols



SPRAGUE-CHADWICK House, 307 Randolph

(Feeney-Barber); all appear to be original to the houses.

ROOFS

The standing-seam metal roofs now seen on many of our Federal period houses date from the late 19th or early 20th century.



All the attics the writer has been able to check thus far show either nail evidence of, or the presence of, hand-cut wood shingles, usually of heart cedar. The shingles were first sliced off with a "fro" knife and then smoothed with a drawknife. They strongly resemble a modern sawn shingle in size and thickness, except they are only about four inches wide. Those in the attic of the 1814 LeRoy Pope House are "fish-scale" round-butt design, whereas all others found thus far are square-butt. The shingles are attached with small cut nails onto rough decking slabs of wood, which usually have the bark still on the edges and have been nailed onto the roof joists.

Gutters were usually (based on surviving examples) let down into the drip-eaves of the roof to conceal them. They apparently tended to leak, for most have been covered and abandoned for decades. The gutters and

drainspouts were metal, and the tinsmith's art was quite refined. Some beautiful examples of snipped-metal leader heads are at Echols Hill and (in storage) at the Weeden House.

Gable ends of roofs were typically cut flush with the gable wall (Weeden and Feeney-Barber houses). Those Federal period houses that now have overhanging gable eaves have been extended later, as joints in the eave-ends testify (Steele-Coons House and Public Inn). The rake-fascias on the gable slopes were usually tapered in width toward the ridge and beaded on the bottom edge, which produces a graceful design. An example is the west service building at Echols Hill.

Drip-eaves ranged from a simple boxed cornice to elaborate modillioned and molded cornices such as those on the Weeden House. Sometimes these cornices were simply cut off

Rake-fascia on west service building of the POPE House.



flat at the house end (Feeney-Barber), and sometimes were gracefully mitered and returned as at the Weeden House.

WOOD COMPONENTS

While most of our surviving Federal period houses are brick, the wood ones have simply been more vulnerable. At least four frame dwellings have been lost in the last three years (Gov. Gabriel Moore House, Kelley House, and one house each on S. Greene Street and Banister Alley). The wooden houses are framed in a method almost identical in structure to a modern house. There are joists, sills, studs, and rafters just like today, except the members are much heavier in section to allow for the loss of strength due to the cutouts at the mortise, tenon and peg connections. Roman numerals chiseled into the wood indicate that the heavy frame and its connections were prefabricated on the

ground and then erected, using the numbered joints to correctly assemble the components. Cut nails were used to attach flooring, clapboarding, lath, trim and other light members.

Wood components were made by squaring the log with an ax and then pit-sawing it into boards. Floor joists were sometimes "puncheons," a log with the top flattened to receive the flooring. Flooring and clapboarding were usually sash-sawn (a steam or water powered up-and-down saw), and lath was hand split. Even the 1814 LeRoy Pope House has mechanically sawn original heart pine 5/4 inch flooring. Large mechanical sash sawmills were in operation as early as the late 1700s in the North. Moldings were hand-planed using shaped molding planes; steam-powered molding-plane machines began to be used in the 1830s in some parts of the country.

Flooring was installed di-

Cornice and gable wall of WEEDEN House.



Nineteenth century framing illustrating mortised, tenoned and pegged joints.

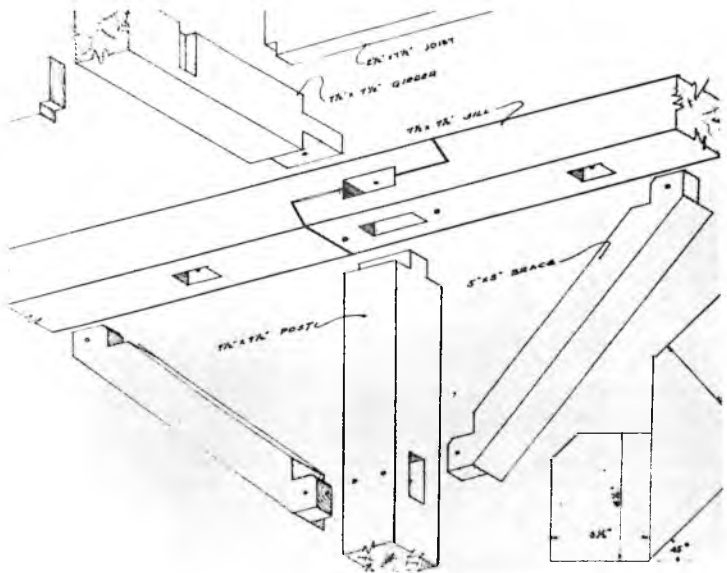

rectly on the joists without a subfloor. The boards were about 1 1/8 inches thick and varied from about five to eight inches wide. An exception is the 1819 Weeden House entry which has original flooring about 2 1/2 inches wide with atypically tight joints. This floor, unlike most, was apparently intended to be exposed rather than covered with carpeting or matting. Several widths of floor boards would frequently be installed in the same room. Period drawings and paintings tell us that floors in this period were generally covered or substantially covered with carpeting, rugs, straw matting, or painted canvas. Therefore the prominent cracks between the boards were not of great concern visually.

In Madison County, most flooring was of heart pine--a very dense, heavy wood that bears no resemblance to the pulpy, light modern pine. To-

day's "dense" grade pine has about six growth rings per inch, whereas the Federal period heart pine sometimes has 25 or more rings per inch. In addition to pine, many floors were heart poplar, and examples of ash and oak have been observed. The flooring was normally tongued-and-grooved, but some was butt-jointed. The neat cut "sprig" nail heads were normally exposed. These floors were scrubbed, but not varnished; varnished floors became popular after the Civil War.

Heart poplar was a favorite wood for house frames, clapboard, and finished pieces, such as doors and moldings. It is rot and insect resistant, cuts like butter, and accepts intricate shaping. Pine was also much used for framing and trim. While this pine was relatively resistant to rot and insects, it was more apt to be damaged than heart poplar.

The wooden mantels (properly termed chimney-pieces) were where the Adamesque neoclassic flamboyance was most strongly expressed. Sunbursts, urns, colonettes, and acanthus leaves were among the devices used in the seemingly endless variety of carvings. The mantel shelf frequently was composed of several deep, flaring molds similar to plate 27 in Asher Benjamin's *The American Builder's Companion* of 1827.

In the more ambitious houses, the stair-tread ends were ornamented with scrollwork cut from thin boards (about 1/4 inch thick) with a scrollsaw. The newel posts were miniature Tuscan colonettes with a knobbed block on top to receive a rounded rail. The balusters were slim and rectangular in section--not turned--and were placed two to a tread. A few houses had graceful curved stairs (Cox-Hilson and Weeden) or scroll-ended rails with no newel. The simpler houses had

rectangular rails and newels with rounded tops. These slim, simple balustrades reflect the lightness of scale of the Federal period in contrast to the heavier Georgian trim.

The use of sandpaper was apparently confined to furniture. Plane marks can usually be seen or felt on doors or other "flat" surfaces.

Doors were most frequently six-paneled, but sometimes four-paneled (Kelley House). Board-and-batten or laminated-board doors were used in utilitarian locations (Phelps-Jones House). The panels were flat on the less prominent side and raised and beveled on the other side. A few panels are beaded-edged and as thick as the rails and stiles. The almost universal practice of beveling only the more prominent side of the panels informs us that our ancestors also felt that money should be spent where it shows, and that human nature is a very

A Federal period mantel in the POPE House illustrating the use of Adamesque motifs such as sunburst designs, colonettes, and deep, flaring molds.



constant thing.

Most rooms examined had chair rails which were an extension of the window sill and

apron profile, although many of these have been removed at some later date. Conversely, the writer has yet to find a Federal period house in this area

Federal period stairway, FEENEY-BARBER House.



that originally had room cornices, although many have been added in recent years. We should resist the urge to "improve" history. (Some Federal balustrades have been removed and discarded in favor of modern miniature "Georgian" versions.) Early paint evidence at the Weeden House indicates that approximately 18 inch wide wallpaper borders were sometimes used to trim the tops of rooms, even in conjunction with painted walls.

Trim was installed in the house prior to the plaster work --the reverse of today's procedure. Baseboards were scribed to the floor without a shoemold, although many shoemolds have been added as settlement occurred. Baseboard tops and door and sash frame edges were beaded for better appearance and to lessen splintering of the edge. Clapboards were frequently beaded on the bottom exposed edge for the same reasons.

BRICK AND STONE

Since limestone was plentiful and easily worked, it is found in the foundations of all Federal period brick or wood houses the writer recalls. Frequently it extends out of the ground, not higher than the first floor. It was laid in a hand chiseled ashlar or random ashlar (coursed) bond. The writer has observed no "rubble" bond walls of this period: they were always coursed, probably because of the low-strength lime mortar that was used. The stones were sometimes quite heavy--about three feet by one foot square (approximately 500 pounds). One wonders how they were handled.

In rural houses, limestone was frequently used for chim-

neys. A typical pattern was to use stone up to the top of the chimney shoulders and then to continue with brick for the top, thin portion of the chimney. While this appears strange to us, it was logical and economical, and there are many such chimneys in the county to demonstrate the prevalence of the practice.

Every early house has its legend of the brick being made "right on the grounds," but we know that the architect and builder George Steele was making brick commercially in Huntsville in the 1820s. We also know, from looking at the houses, that brick was made in both "select" and "common" grades. The select brick is found on the front of the house, usually laid in an attractive but expensive Flemish bond (alternate bricks turned endways), and the common brick is on the sides and rear, laid in the least costly "common bond." Only one house in the county has been observed thus far to have Flemish bond on all sides --the late 1820s Bone-Wilbourn House.

At least two Federal period houses in Limestone County have molded-shaped brick cornices and water tables, but none are known to survive in Madison County. Molded-shaped brick is found here to form some Greek Revival column bases and capitals, and it is likely that it existed in the Federal period.

The pre-1820 Phelps-Jones House on Pulaski Pike has a rarity for Alabama, according to Robert Gamble of the Historic American Buildings Survey; the flat arches that form the sash lintels are made of gauged (tapered) and rubbed brick. The rubbing smoothes the faces and imparts a richer color to

the bricks, and the gauging makes for uniform neat joints in the radiating arch bricks.

A subtle and attractive refinement of the brick Bone-Wilbourn House is that the top floor sash openings are narrower and shorter than those at the first floor, imparting a sort of entasis to the facade by making the bottom appear heavier and bigger than the top. This detail harkens back to the 18th century and is to be found in such Georgian examples as the Wythe House in Williamsburg, Virginia.

Brick houses almost always had somewhat irregular troweled mortar joints that were then routinely "penciled" with 1/4 inch wide stripes of white paint to dress up the irregular joints. An exception is the 1819 Grove-Bassett House, which has beaded joints on the front. An article in the *Association for Preservation Technology Bulletin*

states that this was a common practice after the Revolutionary War when inexpensive apprentice labor to tool the joints was harder to come by.

Lintels over windows were sometimes faced with stucco in a flat wedge shape imitative of a stone lintel. The flat brick work was recessed about an inch to receive the stucco, as can be seen on the south half of the Rhett House where the stucco has come off. Perhaps the plentiful real limestone was not used due to lack (or cost) of stone sawing equipment.

HARDWARE

Since the doors were very thin (about 1 1/4 inches), mortised locks have not been observed here, although they did exist in this period. Rimlocks, mounted on the surface of the thin doors, had to be used. Most frequently they were the type licensed in the early

BONE-WILBOURN House, Hurricane Creek Road



1800s by L. E. Carpenter & Sons to be made by various manufacturers. This was a refinement of a lift-latch (the striker does not retract) with the latch encased in a black iron box and with small brass knobs. The circular brass trademark near the knob shows the rampant lions of the Carpenter brand.

House doors had leaf hinges that look much like modern hinges except that they were of cast iron, cleverly cast as a unit (for economy) so that the pins were integral and could not be pulled out.

Utilitarian doors had blacksmith made strap iron hinges and lift-latches or carved wooden hinges and latches. The wood hinges also served as a batten, stretching across the width of the door boards. The pintle was a wooden dowel attached to the jamb, projecting up through a hole drilled in the wooden strap. Leather hinges are also known to have been used, according to historical accounts. Latches might be either a thumb-latch or lift-latch. The entry door was secured from inside by a wooden bar laid across the door, cradled in iron or wooden brackets.

The strap iron hinges had various attractive decorative ends in the shape of hearts, spears, tadpoles, or ovals. An "S" strap on a wall brace in Maysville has snake-head ends. The most beautiful blacksmith work is in the footscrapers, some of which are minor works of sculpture.

Perhaps there is no great mystery to smithing, however. Several years ago John Martz of Huntsville became interested in Federal period hardware and received permission to use the Kelley blacksmith shop at Jeff.

Within a couple of hours, with no instruction and no previous experience, he had a beautiful strap hinge. If there was any problem with it, it was that it was better made than most of the antique ones. Jim Batson has recently done some fine blacksmith work for the hardware at the Constitution Park reconstructions.

The cut nails of the early 1800s are, to many people's surprise, machine made. The first cut nail factories began in the late 1700s, and by the early 1800s, virtually all were made by either steam or water powered machines. We tend to romanticize the early 1800s and forget that it was the age of the Industrial Revolution. A few special shaped handmade nails have been observed that could not be made on the machines available, but they are rare exceptions.

Surviving hinges for blinds are cast iron, known to have been available in the Federal period. Strap hinges were likely to have been in use on blinds too, for they survive on even later buildings in other parts of Alabama. The Bone-Wilbourn House has handmade "S" scroll holdbacks, and various other types of blacksmith-made holdbacks can be seen in the county.

PAINT AND WALLPAPER

Contrary to almost everyone's belief, the interiors of Federal period houses were infrequently painted cream or white. The colors used, based on several examined, were usually deep and rich--burgundy, turquoise, forest green, powder blue, and rose pink. Mantels were most frequently black or partly black with shiny varnish over the black paint to high-

light the Adamesque shapes. That this was a common decorative theme is borne out in *Americans at Home and Recreating the Historic House Interior*, while the deep, rich colors can be seen in the plates of *The Work of Robert Adam*. The black mantels nicely complemented these rich wall colors.

Wallpaper was also available according to contemporary newspaper advertisements. Traces of a delicate pattern were found stained on the plaster of the 1814 LeRoy Pope House in 1979.

Doors were most frequently "grained" to imitate various woods. Burlled panels were frequent. In the Weeden House, most of the other interior trim was also grained.

SUMMARY

While our Federal period houses may appear at first to be simple and almost identical in design, there is an enormous variety in their detail. As with any other worthy subject, study and increased knowledge bring an increased appreciation and understanding and a realization of how much is not yet known or understood. We have barely scratched the surface of understanding our architectural heritage from the early 19th century (or any other time). We should continue to care for this heritage, for even with care, more will be lost by destruction or by attrition. Perhaps attrition is the more dangerous loss, since it sneaks up on us. One small change does not seem serious, but a small change every ten years for 160 years becomes serious indeed. To emphasize these points, this paper does not address Federal period commercial or public architecture

for the simple reason that we have lost it all. Twenty years ago, we still had several examples. It is now too late to study and appreciate it--it is gone. Let us endeavor to see that this does not happen to any other segment of our architectural history!

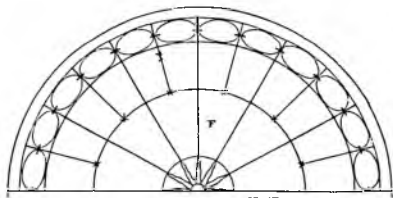

- 1 A task yet to be done is to compare Huntsville's Federal period detail with these handbooks (the UAH library has a collection of them) to determine some of the handbooks that were in use here.
- 2 As recently as this century, my grandmother's 1820s parlor contained a bed, and my father and his brothers slept four to one bed.
- 3 From an unpublished manuscript, "Memories of Lillian Bone Paul," of life in the 1820s Bone-Wilbourn House in Hurricane Valley, written in the late 19th century.

ADDITIONAL FEDERAL PERIOD
FLOOR PLANS

SIDE-HALL & REAR WING PLAN
(Ex. Cabaniss-Roberts
603 Randolph)

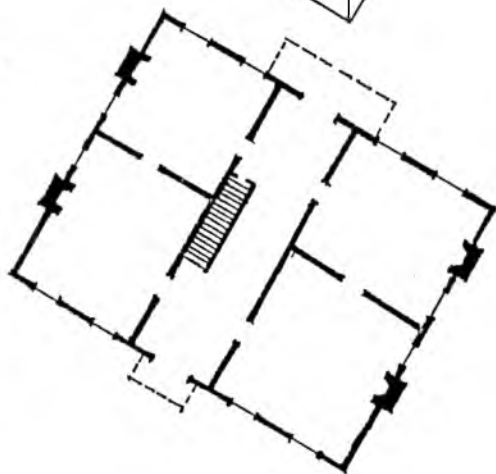
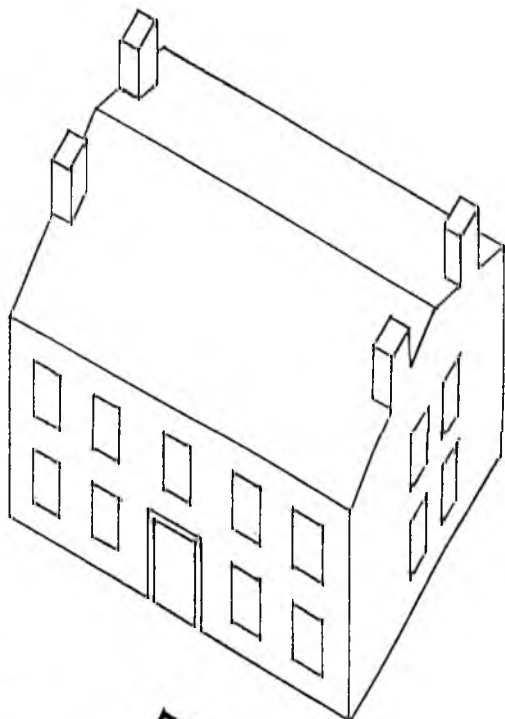
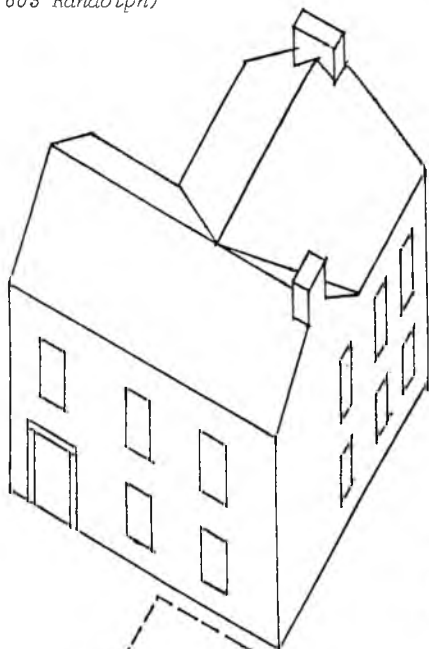

CENTER-HALL PLAN
(Ex. Pynchon-Powell
518 Adams)

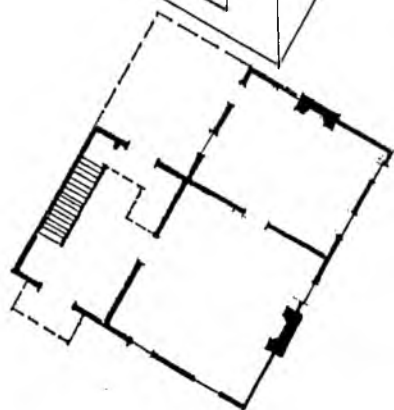

SELECTED BIBLIOGRAPHY

- Beard, Geoffrey. *The Work of Robert Adam*. ARCO, 1978.
- Benjamin, Asher. *The American Builder's Companion*. Dover reprint (1969), 1827.
- Bullock, Orin M., Jr., A.I.A. *The Restoration Manual*. Silvermine Publishers, 1966.
- de Franciscis-Crescent. *Pompeii and Herculaneum*. 1978.
- Glimpses into Ante-Bellum Homes*. Huntsville, American Association of University Women, 1976.
- Great Georgian Houses of America*. Dover, 1970.
- Historical American Buildings Survey Drawings. Library of Congress.
- Historical Photograph Collection. Jones & Herrin, Architects, A.I.A., Huntsville.
- Peterson, Harold L. *Americans at Home*. Scribners, 1971.
- Pierson, William H. *American Buildings and Their Architects: The Colonial and Neo-Classical Styles*. Anchor Books, 1976.
- Seale, William. *Recreating the Historic House Interior*. American Association for State and Local History, 1979.
- Whiffen, Marcus. *American Architecture Since 1780*. M.I.T. Press, 1969.
- . *The Eighteenth Century Houses of Williamsburg*. Holt, Rinehart and Winston, 1960.
- Williams, H. L. and O. K. Williams. *Great Houses of America*. Putnams, 1969.



NON-PROFIT ORG.
U.S. Postage
PAID
PERMIT # 34
Huntsville, AL

from

Historic Huntsville Foundation, Inc.

P. O. Box 786

Huntsville, Alabama 35804